

Data sheet | Item number: 765-1105/100-000

8-channel digital input/output; Profinet; DC 24 V / 2.0 A; 8xM8 connection;
SlimLine

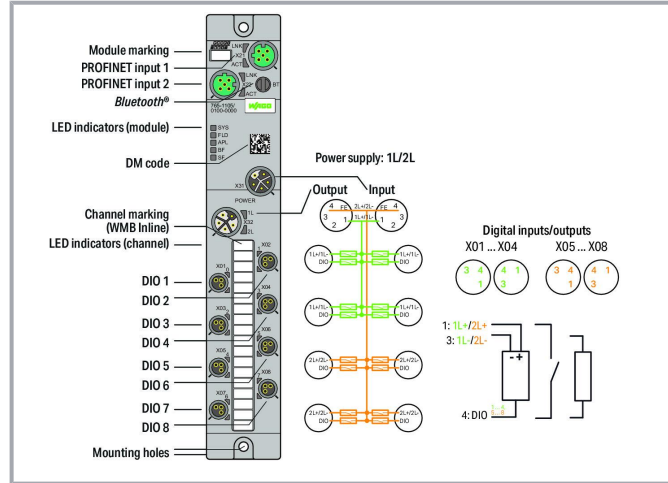

www.wago.com/765-1105/100-000



Data

Technical data

Fieldbus

Communication	PROFINET PROFINET IO Device; 2-port switch, LLDP, MRP, SNMP PROFINET PROFINET IO Device; 2-port switch, LLDP, MRP, SNMP
Connection technology: communication/fieldbus	2 x D-coded M12; 4-pole
Interface standard	10BASE-T/100BASE-TX; potential-free
Autonegotiation; autocrossover	yes
PROFINET IO properties	PROFINET IO device; 2-port switch, LLDP, MRP, SNMP

Device Functions

Parameters	Input filter Output current
------------	--------------------------------

Subject to changes. Please also observe the further product documentation!

WAGO GmbH & Co. KG
Hansastr. 27
32423 Minden
Phone: +49571 887-0 | Fax: +49571 887-169
Email: info.de@wago.com | Web: www.wago.com

Do you have any questions about our products?
We are always happy to take your call at +49 (571) 887-44222.



	Temperature
Diagnostics	Undervoltage; Overcurrent; Overload; Overtemperature
Device functions	Bluetooth® Bluetooth® OPC UA Server
Visualization	Android/iOS app Webserver

Digital inputs/outputs

Number of digital inputs	8
Number of digital outputs	8
Connection technology: inputs/outputs	8 x M8; 3-pole
Voltage signal type	24 VDC
Input characteristic	High-side switching
Input filter	0.2 ... 20 ms
Input characteristic	Type 3, per IEC 61131-2
Output current (per channel)	2 A (typ.) for DO
Supply current per port	1L/2L: 4 A (max.)

Module Power Supply

Connection technology: supply	2 x L-coded M12; 5-pole
Supply voltage	24 VDC (18 ... 31.2 V); 1L/2L
Power consumption (max.)	16000 mA
Power consumption (note)	per supply line; overload- and short-circuit-protected
Reverse voltage protection	Yes

Geometrical Data

Width	35 mm / 1.378 inch
Height	30 mm / 1.181 inch
Depth	210 mm / 8.268 inch

Mechanical Data

Weight	390 g
Conformity marking	CE

Environmental Requirements

Surrounding air temperature (operation)	-25 ... +70 °C
-----------------------------------------	----------------

Subject to changes. Please also observe the further product documentation!

Surrounding air temperature (storage)	-40 ... +80 °C
Protection type	IP67
Protection class	III per EN 61140, IEC 61140, VDE 0140-1
Operating altitude	0 ... 2000 m
Pollution degree (5)	3 per EN 60664-1
Overvoltage category	II (EN 60664-1)
Relative humidity (without condensation)	95 %
Vibration resistance	5g per IEC 60068-2-6
Shock resistance	Short-term: 50g/11 ms/half-sine per IEC 60068-2-27; Long-term: 30g/6 ms/half-sine per IEC 60068-2-29
EMC immunity to interference	per EN 61000-6-2
EMC emission of interference	per EN 61000-6-4

Commercial data



PU (SPU)	1 Stück
Packaging type	box
Country of origin	DE
GTIN	4055143949705
Customs tariff number	85371098990

Required accessories

Cover

Cover		
	Item no.: 756-8102 M12 protective cap; for unused sockets	www.wago.com/756-8102
	Item no.: 756-8103 M12 protective cap; for unused plugs	www.wago.com/756-8103
	Item no.: 756-8101 M8 protective cap; for unused sockets	www.wago.com/756-8101

Marking accessories

Marking strip		
	Item no.: 2009-110 Marking strips; for Smart Printer; on reel; not stretchable; plain; snap-on type; white	www.wago.com/2009-110
Marker		
	Item no.: 2009-115 WMB-Inline; for Smart Printer; 1500 pieces on roll; stretchable 5 - 5.2 mm; plain; snap-on type; white	www.wago.com/2009-115

Tool

Subject to changes. Please also observe the further product documentation!

Assembly tool

Item no.: 206-701

Torque wrench M8 and M12; Assembly kit

www.wago.com/206-701

Optional accessories

Cables and pluggable connectors

Sensor/actuator cable

Item no.: 756-5501/030-020

Sensor/Actuator cable; M12A socket; straight; M8 plug; straight; 3-pole; Length: 2 m

www.wago.com/756-5501/030-020

Item no.: 756-5502/030-010

Sensor/Actuator cable; M12A socket; straight; M8 plug; angled; 3-pole; Length: 1 m

www.wago.com/756-5502/030-010

Item no.: 756-5502/030-020

Sensor/Actuator cable; M12A socket; straight; M8 plug; angled; 3-pole; Length: 2 m

www.wago.com/756-5502/030-020

Item no.: 756-5503/030-010

Sensor/Actuator cable; M12A socket; angled; M8 plug; straight; 3-pole; Length: 1 m

www.wago.com/756-5503/030-010

Item no.: 756-5503/030-020

Sensor/Actuator cable; M12A socket; angled; M8 plug; straight; 3-pole; Length: 2 m

www.wago.com/756-5503/030-020

Item no.: 756-5111/030-015

Sensor/Actuator cable; M8 plug; straight; 3-pole; Length: 1.5 m

www.wago.com/756-5111/030-015

Item no.: 756-5111/030-050

Sensor/Actuator cable; M8 plug; straight; 3-pole; Length: 5 m

www.wago.com/756-5111/030-050

Item no.: 756-5111/030-100

Sensor/Actuator cable; M8 plug; straight; 3-pole; Length: 10 m

www.wago.com/756-5111/030-100

Item no.: 756-5112/030-100

Sensor/Actuator cable; M8 plug; angled; 3-pole; Length: 10 m

www.wago.com/756-5112/030-100

Item no.: 756-5112/030-015

Sensor/Actuator cable; M8 plug; angled; 3-pole; Length: 1.5 m

www.wago.com/756-5112/030-015

Item no.: 756-5112/030-050

Sensor/Actuator cable; M8 plug; angled; 3-pole; Length: 5 m

www.wago.com/756-5112/030-050

Subject to changes. Please also observe the further product documentation!

WAGO GmbH & Co. KG

Hansastr. 27



32423 Minden

Phone: +49571 887-0 | Fax: +49571 887-169

Email: info.de@wago.com | Web: www.wago.com

Do you have any questions about our products?

We are always happy to take your call at +49 (571) 887-44222.

<p>Item no.: 756-5201/030-010 Sensor/Actuator cable; M8 socket; straight; M8 plug; straight; 3-pole; Length: 1 m</p>	<p>www.wago.com/756-5201/030-010</p>	
<p>Item no.: 756-5201/030-020 Sensor/Actuator cable; M8 socket; straight; M8 plug; straight; 3-pole; Length: 2 m</p>	<p>www.wago.com/756-5201/030-020</p>	
<p>Item no.: 756-5202/030-020 Sensor/Actuator cable; M8 socket; straight; M8 plug; angled; 3-pole; Length: 2 m</p>	<p>www.wago.com/756-5202/030-020</p>	
<p>Item no.: 756-5202/030-010 Sensor/Actuator cable; M8 socket; straight; M8 plug; angled; 3-pole; Length: 1 m</p>	<p>www.wago.com/756-5202/030-010</p>	
<p>Item no.: 756-5203/030-010 Sensor/Actuator cable; M8 socket; angled; M8 plug; straight; 3-pole; Length: 1 m</p>	<p>www.wago.com/756-5203/030-010</p>	
<p>Item no.: 756-5203/030-020 Sensor/Actuator cable; M8 socket; angled; M8 plug; straight; 3-pole; Length: 2 m</p>	<p>www.wago.com/756-5203/030-020</p>	
	<p>Item no.: 756-5204/030-020 Sensor/Actuator cable; M8 socket; angled; M8 plug; angled; 3-pole; Length: 2 m</p>	<p>www.wago.com/756-5204/030-020</p>
	<p>Item no.: 756-5204/030-010 Sensor/Actuator cable; M8 socket; angled; M8 plug; angled; 3-pole; Length: 1 m</p>	<p>www.wago.com/756-5204/030-010</p>
<p>Item no.: 756-5501/030-010 Sensor/Actuator cable; M12A socket; straight; M8 plug; straight; 3-pole; Length: 1 m</p>	<p>www.wago.com/756-5501/030-010</p>	
<p>Item no.: 756-5504/030-010 Sensor/Actuator cable; M12A socket; angled; M8 plug; angled; 3-pole; Length: 1 m</p>	<p>www.wago.com/756-5504/030-010</p>	
<p>Item no.: 756-5504/030-020 Sensor/Actuator cable; M12A socket; angled; M8 plug; angled; 3-pole; Length: 2 m</p>	<p>www.wago.com/756-5504/030-020</p>	
<p>Configurable connectors</p>		
<p>Item no.: 756-9102/030-000 Fitted pluggable connector; 3-pole; M8 plug, straight; IDC technology</p>	<p>www.wago.com/756-9102/030-000</p>	
	<p>Item no.: 756-9105/030-000 Fitted pluggable connector; 3-pole; M8 plug, right angle; IDC technology</p>	<p>www.wago.com/756-9105/030-000</p>

Subject to changes. Please also observe the further product documentation!



Item no.: 756-9711/050-000

Fitted pluggable connector; 5-pole, shielded; M12 socket, straight; IDC technology

www.wago.com/756-9711/050-000



Item no.: 756-9701/050-000

Fitted pluggable connector; 5-pole, shielded; M12 plug, straight; IDC technology

www.wago.com/756-9701/050-000

Configurable shielded connectors

Item no.: 756-9501/060-000

Fitted pluggable connector; 5-pole, shielded; M12 plug, straight, D-coded; Spring

www.wago.com/756-9501/060-000

Item no.: 756-9501/040-000

Accessories; M12 plug, right angle; 4-pole

www.wago.com/756-9501/040-000

Power cable



Item no.: 756-3501/050-075

Power cable; M12L socket; straight; 5-pole; Length: 7.5 m

www.wago.com/756-3501/050-075



Item no.: 756-3501/050-100

Power cable; M12L socket; straight; 5-pole; Length: 10 m

www.wago.com/756-3501/050-100



Item no.: 756-3501/050-150

Power cable; M12L socket; straight; 5-pole; Length: 15 m

www.wago.com/756-3501/050-150



Item no.: 756-3501/050-050

Power cable; M12L socket; straight; 5-pole; Length: 5 m

www.wago.com/756-3501/050-050



Item no.: 756-3502/050-050

Power cable; M12L socket; angled; 5-pole; Length: 5 m

www.wago.com/756-3502/050-050



Item no.: 756-3502/050-150

Power cable; M12L socket; angled; 5-pole; Length: 15 m

www.wago.com/756-3502/050-150

Subject to changes. Please also observe the further product documentation!

WAGO GmbH & Co. KG

Hansastr. 27













32423 Minden

Phone: +49571 887-0 | Fax: +49571 887-169













Email: info.de@wago.com | Web: www.wago.com

Do you have any questions about our products?

We are always happy to take your call at +49 (571) 887-44222.

	Item no.: 756-3502/050-075 Power cable; M12L socket; angled; 5-pole; Length: 7.5 m	www.wago.com/756-3502/050-075
	Item no.: 756-3502/050-100 Power cable; M12L socket; angled; 5-pole; Length: 10 m	www.wago.com/756-3502/050-100
	Item no.: 756-3503/050-075 Power cable; M12L plug; straight; 5-pole; Length: 7.5 m	www.wago.com/756-3503/050-075
	Item no.: 756-3503/050-150 Power cable; M12L plug; straight; 5-pole; Length: 15 m	www.wago.com/756-3503/050-150
	Item no.: 756-3503/050-100 Power cable; M12L plug; straight; 5-pole; Length: 10 m	www.wago.com/756-3503/050-100
	Item no.: 756-3505/050-003 Power cable; M12L socket; straight; M12L plug; straight; 5-pole; Length: 0.3 m	www.wago.com/756-3505/050-003
	Item no.: 756-3505/050-005 Power cable; M12L socket; straight; M12L plug; straight; 5-pole; Length: 0.5 m	www.wago.com/756-3505/050-005
	Item no.: 756-3505/050-020 Power cable; M12L socket; straight; M12L plug; straight; 5-pole; Length: 2 m	www.wago.com/756-3505/050-020
	Item no.: 756-3505/050-010 Power cable; M12L socket; straight; M12L plug; straight; 5-pole; Length: 1 m	www.wago.com/756-3505/050-010
	Item no.: 756-3505/050-050 Power cable; M12L socket; straight; M12L plug; straight; 5-pole; Length: 5 m	www.wago.com/756-3505/050-050
	Item no.: 756-3505/050-075 Power cable; M12L socket; straight; M12L plug; straight; 5-pole; Length: 7.5 m	www.wago.com/756-3505/050-075
	Item no.: 756-3505/050-100 Power cable; M12L socket; straight; M12L plug; straight; 5-pole; Length: 10 m	www.wago.com/756-3505/050-100

Subject to changes. Please also observe the further product documentation!

	Item no.: 756-3506/050-100 Power cable; M12L socket; angled; M12L plug; angled; 5-pole; Length: 10 m	www.wago.com/756-3506/050-100
	Item no.: 756-3506/050-075 Power cable; M12L socket; angled; M12L plug; angled; 5-pole; Length: 7.5 m	www.wago.com/756-3506/050-075
	Item no.: 756-3506/050-150 Power cable; M12L socket; angled; M12L plug; angled; 5-pole; Length: 15 m	www.wago.com/756-3506/050-150
	Item no.: 756-3501/050-020 Power cable; M12L socket; straight; 5-pole; Length: 2 m	www.wago.com/756-3501/050-020
	Item no.: 756-3502/050-020 Power cable; M12L socket; angled; 5-pole; Length: 2 m	www.wago.com/756-3502/050-020
	Item no.: 756-3503/050-020 Power cable; M12L plug; straight; 5-pole; Length: 2 m	www.wago.com/756-3503/050-020
	Item no.: 756-3503/050-050 Power cable; M12L plug; straight; 5-pole; Length: 5 m	www.wago.com/756-3503/050-050
	Item no.: 756-3504/050-020 Power cable; M12L plug; angled; 5-pole; Length: 2 m	www.wago.com/756-3504/050-020
	Item no.: 756-3504/050-050 Power cable; M12L plug; angled; 5-pole; Length: 5 m	www.wago.com/756-3504/050-050
	Item no.: 756-3504/050-075 Power cable; M12L plug; angled; 5-pole; Length: 7.5 m	www.wago.com/756-3504/050-075
	Item no.: 756-3504/050-100 Power cable; M12L plug; angled; 5-pole; Length: 10 m	www.wago.com/756-3504/050-100
	Item no.: 756-3504/050-150 Power cable; M12L plug; angled; 5-pole; Length: 15 m	www.wago.com/756-3504/050-150

Subject to changes. Please also observe the further product documentation!



Item no.: 756-3505/050-150
Power cable; M12L socket; straight; M12L plug; straight; 5-pole; Length: 15 m

www.wago.com/756-3505/050-150



Item no.: 756-3506/050-003
Power cable; M12L socket; angled; M12L plug; angled; 5-pole; Length: 0.3 m

www.wago.com/756-3506/050-003



Item no.: 756-3506/050-005
Power cable; M12L socket; angled; M12L plug; angled; 5-pole; Length: 0.5 m

www.wago.com/756-3506/050-005



Item no.: 756-3506/050-020
Power cable; M12L socket; angled; M12L plug; angled; 5-pole; Length: 2 m

www.wago.com/756-3506/050-020



Item no.: 756-3506/050-010
Power cable; M12L socket; angled; M12L plug; angled; 5-pole; Length: 1 m

www.wago.com/756-3506/050-010



Item no.: 756-3506/050-050
Power cable; M12L socket; angled; M12L plug; angled; 5-pole; Length: 5 m

www.wago.com/756-3506/050-050

Adapter



Item no.: 756-9503/040-000
Accessories; 4-pole

www.wago.com/756-9503/040-000

Item no.: 756-9504/040-000
Accessories; 4-pole

www.wago.com/756-9504/040-000

ETHERNET/PROFINET cable



Item no.: 756-1202/060-200
ETHERNET cable; M12D plug; angled; 4-pole; Length: 20 m

www.wago.com/756-1202/060-200



Item no.: 756-1201/060-100
ETHERNET cable; M12D plug; straight; 4-pole; Length: 10 m

www.wago.com/756-1201/060-100



Item no.: 756-1201/060-050
ETHERNET cable; M12D plug; straight; 4-pole; Length: 5 m













www.wago.com/756-1201/060-050



Item no.: 756-1203/060-050
ETHERNET cable; M12D plug; straight; M12D plug; straight; 4-pole; Length: 5 m

www.wago.com/756-1203/060-050

Subject to changes. Please also observe the further product documentation!

	Item no.: 756-1203/060-020 ETHERNET cable; M12D plug; straight; M12D plug; straight; 4-pole; Length: 2 m	www.wago.com/756-1203/060-020
	Item no.: 756-1202/060-020 ETHERNET cable; M12D plug; angled; 4-pole; Length: 2 m	www.wago.com/756-1202/060-020
	Item no.: 756-1201/060-200 ETHERNET cable; M12D plug; straight; 4-pole; Length: 20 m	www.wago.com/756-1201/060-200
	Item no.: 756-1204/060-050 ETHERNET cable; M12D plug; angled; M12D plug; angled; 4-pole; Length: 5 m	www.wago.com/756-1204/060-050
	Item no.: 756-1204/060-100 ETHERNET cable; M12D plug; angled; M12D plug; angled; 4-pole; Length: 10 m	www.wago.com/756-1204/060-100
	Item no.: 756-1204/060-200 ETHERNET cable; M12D plug; angled; M12D plug; angled; 4-pole; Length: 20 m	www.wago.com/756-1204/060-200
	Item no.: 756-1203/060-200 ETHERNET cable; M12D plug; straight; M12D plug; straight; 4-pole; Length: 20 m	www.wago.com/756-1203/060-200
	Item no.: 756-1203/060-100 ETHERNET cable; M12D plug; straight; M12D plug; straight; 4-pole; Length: 10 m	www.wago.com/756-1203/060-100
	Item no.: 756-1204/060-010 ETHERNET cable; M12D plug; angled; M12D plug; angled; 4-pole; Length: 0.1 m	www.wago.com/756-1204/060-010
	Item no.: 756-1204/060-030 ETHERNET cable; M12D plug; angled; M12D plug; angled; 4-pole; Length: 3 m	www.wago.com/756-1204/060-030
	Item no.: 756-1204/060-020 ETHERNET cable; M12D plug; angled; M12D plug; angled; 4-pole; Length: 2 m	www.wago.com/756-1204/060-020
	Item no.: 756-1202/060-050 ETHERNET cable; M12D plug; angled; 4-pole; Length: 5 m	www.wago.com/756-1202/060-050

Subject to changes. Please also observe the further product documentation!



Item no.: 756-1202/060-100
ETHERNET cable; M12D plug; angled; 4-pole; Length: 10 m

www.wago.com/756-1202/060-100



Item no.: 756-1201/060-020
ETHERNET cable; M12D plug; straight; 4-pole; Length: 2 m

www.wago.com/756-1201/060-020

Downloads

Documentation

Manual

8-Channel Digital Input/Output; Profinet DC 24 V / 2.0 A; 8xM8 Connection; SlimLine	V 2.1.0 2020年11月30日	pdf 3.8 MB	Download
----------------------------------------------------------------------------------------	------------------------	---------------	----------

System Description

WAGO I/O System Field; General Product Information		pdf 708.2 kB	Download
----------------------------------------------------	--	-----------------	----------

Runtime Software

Firmware

Profinet IO-Field 765-x1xx Firmware Download WAGO_FW0765-x1xx_V01010016_IX02.zip	V 02 2021年7月23日	zip 1.6 MB	Download
-------------------------------------------------------------------------------------	--------------------	---------------	----------

CAD/CAE-Data

CAD data

2D/3D Models 765-1105/100-000		URL	Download
-------------------------------	--	-----	----------

CAE data

ZUKEN Portal 765-1105/100-000		URL	Download
-------------------------------	--	-----	----------

Device Files

Device Description File

Subject to changes. Please also observe the further product documentation!



750-916; GSD-Dateien der Version 2.x für PROFINET/ Serie 750/753, 765, 767 und 852	2.9 2021年10月15日	zip 2.5 MB	Download
Gerätebeschreibungsdateien 765-41xx, 765-11xx, PROFINET	V1_1_0_20	zip 27 B	Download

Environmental Product Compliance

Compliance Search

Environmental Product Compliance 765-1105/100-000	URL	Download
8-channel digital input/output; Profinet; DC 24 V / 2.0 A; 8xM8 connection; SlimLine		

Installation Notes

Product family

WAGO I/O System Field
[Show all products from the family](#)

Subject to changes. Please also observe the further product documentation!

WAGO GmbH & Co. KG
Hansastr. 27
32423 Minden
Phone: +49571 887-0 | Fax: +49571 887-169
Email: info.de@wago.com | Web: www.wago.com

Do you have any questions about our products?
We are always happy to take your call at +49 (571) 887-44222.